

Installations 101

Installation Guidelines & Tips



MIRACLE
RECREATION EQUIPMENT COMPANY



MIRACLE
RECREATION EQUIPMENT COMPANY

Table of Contents

D70050 Rev. B

<u>Sec.</u>	<u>Description</u>	<u>Doc. #</u>
100	Table of Contents	D70050
200	Important Notes	D70051
300	Suggested Tools & Equipment for Miracle Playsystem Installations	D70052
350	Pre-Installation Check List	D70059
400	Playsystem Installation Guidelines and Tips	D70053
500	Placement of "Age Appropriate" Labels	D70054
550	Placement of "Warning" Labels and "Manufacturers I.D." Labels	D70058
600	Torque Chart	D70055
700	Hardware Guide	D70066

"Installations 101" contains information pertinent to playsystem installations. For safety, maintenance and other important instructions, refer to "Read Me First!" located at the front of this Installation Manual.



MIRACLE
RECREATION EQUIPMENT COMPANY

Important Notes

D70051 Rev. D

1. Before installing or erecting this equipment, please read and comply with all applicable recommendations in **Safety Brochure 100**, located in "Read Me First!" elsewhere in this manual. If for some reason this brochure is missing, contact your Miracle Sales Representative for a copy.
2. Before starting construction, check with all utility companies for exact locations of underground utilities.
3. When selecting areas for play equipment, consideration should be given to soil types and subgrade characteristics. The purchaser and/or installing contractor will be responsible for proper installation, including proper footings. The footing sizes shown in the installation instructions are appropriate for stable, compacted soil. If the soil is not stable and compacted, or if any other environmental conditions exist (such as constantly wet soil, deep frost line, etc.) then the footing sizes may need to be increased. For example, to reduce frost heave, footing sides should be smooth and footings may be dug deeper.
4. The purchaser and/or installing contractor will be responsible for installing acceptable impact absorbing surfacing material in the playground area (refer to **Safety Brochure 100**), which is generally recommended to be beneath all play structures, as well as a minimum of six (6) feet out from the edges of all playstructures. It is the purchaser's responsibility to maintain these areas properly after installation, ensuring that abnormal and unsafe compaction does not occur in these areas. It is recommended that compaction tests be made several times per year. When compaction occurs, it is recommended that the area affected be scarified or additional loose fill material (pea gravel, sand, redwood bark, coarse wood chips, etc) be added until the area is soft and resilient.
5. **Warning:** Contact burn injuries can occur when metal play surfaces are located in direct sun. To avoid the risk of such burn injuries, the United States Consumer Product Safety Commission recommends in its "Handbook for Public Playground Safety" that metal play surfaces, such as stainless steel slides and bare or painted metal crawl tubes, should be placed/installed in shaded areas, and out of direct sunlight. The proper location of metal play surfaces must be addressed during the play area planning process.



MIRACLE
RECREATION EQUIPMENT COMPANY

Suggested Tools & Equipment for Miracle Playsystem Installations

D70052 Rev. B

1. Concrete for footings. *Refer to each component's Product Specifications for required amounts.*
 - 2000 PSI (minimum)
 - 3000 PSI (minimum if freezing conditions exist)
2. Digging equipment for footing holes (auger, Bobcat with posthole auger, posthole digger, spade shovels, etc.)
3. Patio blocks, 2" x 8" x 16". One half block for every footing hole for deck systems and freestanding components; not necessary on other component installations.
4. Wheelbarrow or concrete mixer with 5-gallon bucket(s); water supply and garden hose.
5. Generator / power source; electrical gang box and extension cord(s).
6. Step ladders.
7. String line and stakes (or transit) to aid in layout.
8. Saw horses.
9. Levels: (2) 9" magnetic torpedo levels, and (1) 4' carpenter's level.
10. Tape measures: (1) 25' and (2) 100'.
11. Open end wrench set. *Refer to Parts Lists and Installation Guides for specific hardware.*
12. Allen wrenches or hex keys. *Refer to Parts Lists and Installation Guides for specific hardware.*
13. Socket set(s). *Refer to Parts Lists and Installation Guides for specific hardware.*
14. Screwdrivers. *Refer to Parts Lists and Installation Guides for specific hardware.*
15. Drift pins.
16. Box knife or knives.
17. C-clamps and vice grips.
18. Electric drill and various-sized drill bits. *Refer to Parts Lists and Installation Guides for specific hardware.*
19. Impact wrench (optional; use extreme caution to avoid damaging parts)
20. Hammers: standard and rubber mallet.
21. Wooden stakes and moving straps.
22. Six or more mechanically-inclined adult volunteer installers and helpers.
23. Crane or Bobcat to lift Typhoon slides, Tube slides, and larger roofs into place.
24. "S" hook pliers for closing "S" hooks on swings, handring bridges, etc.
25. Felt tip pens (washable) for marking clamp locations.
26. Trailer to move equipment if not on site.
27. Refreshments, access to restrooms, litter receptacles.
28. Jacks, support stands (Miracle Model #1000), or blocks to mechanically suspend components while concrete sets.
29. Hand-held grinder.
30. 4" cut-off wheel.
31. Tap & die set: 5/16", 3/8", 1/2"; 7/16", 5/8", etc.
32. Bolt cutter, 24".
33. Tech screwdriver - 5 amp, 2000 RPM optimum.



MIRACLE
RECREATION EQUIPMENT COMPANY

Pre-Installation Check List

D70059 Rev. A

Miracle highly recommends that you visit an existing playground with a similar Miracle playsystem before beginning your installation. Your Miracle Sales Representative can provide you with location(s) of similar systems. This will help you to better understand the scope of work ahead, as well as familiarize you with what the installed, finished product should look like.

SITE LOCATION

Make certain that the selected site is large enough for your Miracle playsystem(s) and for the minimum protective area(s) in your layout plan.

SITE PREPARATION

Make certain that all site preparation is complete, including site leveling and debris removal. Before digging any footing holes, inquire with local utility companies to determine the locations (or absence of) underground utilities.

DRAINAGE

It is important that the sub-surface (i.e. the plane beneath the protective surfacing materials) be able to drain well, to eliminate standing water. If the sub-surface does not drain naturally, it must be tiled or sloped at 1/8" to 1/4" per foot to a "French Drain" or similar system. Larger Miracle playsystems may require more than one "French Drain" to allow drainage from the center of the play area to decrease the overall slope. For more information on draining solutions, contact your Miracle Sales Representative.

HUMAN RESOURCES & EQUIPMENT

If your playsystem installation is to be "Community Built" by volunteers rather than professional installers, Miracle recommends contracting the services of a professional installer to supervise the initial stages of the installation. Miracle also recommends the formation of a committee to handle tasks such as equipment gathering, work teams and assignments, etc. Being prepared for various contingencies will avert common mistakes and save the installers valuable time and effort.



MIRACLE
RECREATION EQUIPMENT COMPANY

Playsystem Installation Guidelines and Tips

D70053 Rev. A

BEFORE BEGINNING INSTALLATION

1. Make certain that all installers understand the safety information provided in this *Installation Manual*. Follow the manufacturer's instructions as closely as possible to install components, and note any discrepancies on the **Post-Installation Check List** (Doc. # D70040) located in *Read Me First!* at the front of this *Installation Manual*.
2. Complete the **Pre-Installation Check List** (Doc. # D70059) in this *Installation Manual*. Do not proceed with installation until all conditions are met.
3. Before starting installation, study your Miracle playsystem layout plan for the correct location of posts, deck heights, and footing information. Stake out your components and areas for protective surfacing. You may wish to "rope off" the work area if children or other observers are present. Make certain that you've contacted the utility company to determine the exact locations of underground wiring, etc.

*NOTE: All footing holes are **not** the same diameter and depth; all deck posts are **not** the same length. Refer to the Construction Drawings and each component's Installation Guide for specific footing details.*

4. Upon receipt of your Miracle play equipment, lay out all parts received and separate them by component. All parts have a part number on them that corresponds to the Bill of Materials lists, found at the back of the *Installation Manual*. You may wish to use small buckets, coffee cans, etc. to keep respective hardware pieces separated.
5. It is important that all installers understand that deck heights are measured from *Finished Grade*, that is, the top of the protective surfacing, which is installed **after** the playsystem and its components. Therefore, measurements for footing holes, clamp heights, etc. should accommodate the protective surfacing depths.

WARNING: If deck heights are mistakenly measured from sub-grade, all slides, steps, transfer points, etc. could be installed too low, and require removal and re-installation!

SAFETY NOTE: Make certain that you have chosen a protective surfacing material that has a Critical Height Value of at least the height of the Highest Accessible Part/Fall height of the adjacent equipment. Refer to CPSC Guidelines, Section 4: Surfacing.

DURING INSTALLATION

1. The optimum installation sequence of Miracle playsystem components will vary. **In general, install decks first, followed by connecting components (bridges, crawl tubes, etc.), followed by deck-mount components, then freestanding components.**

Your installation should begin with the largest centrally-located deck. The site for your playground should be level to ensure proper deck and component heights after installation of your impact-absorbing

surfacing material.

2. Dig footing holes one deck or component at a time and only as you need them. Do not leave holes open overnight or unattended. Make certain that footing holes are dug to proper depths and widths as shown on the *Construction Drawing's* Footing Layout and on the component's *Installation Guide*.

For deck systems and freestanding components, place a patio block half, crushed rock, or equivalent material into the bottom of each footing hole to provide a solid foundation for the deck posts. Account for this in the hole depth, e.g. add 2" to the depth of footing holes that contain patio block support.

3. Install deck systems, according to each system's particular *Installation Guide*. After the deck is attached to its posts, affixing the deck enclosure assemblies to the deck and posts will help stabilize the system, simplifying the mounting of other components.

NOTE: Do not affix with self-drilling screws until system is assembled, leveled and braced in position.

4. When attaching components to deck systems and your *Installation Guide* instructs you to remove excess PVC from the mating holes in the deck face, make certain to drill out **only** those holes.
5. Re-tapping of threaded inserts may be necessary to remove excess paint.
6. All fasteners used in Miracle playground systems are locking, by means of Nylon self-locking nuts, bolts with internal nylon plugs or beads, pre-applied patches of Locktite™-style locking compound, internal tooth lock washers, etc. If you must replace one of the supplied fasteners, obtain a similarly locked fastener, substitute one of the other locking methods described here, or apply Locktite™-style locking compound to the replacement fastener.
7. Use jacks, support stands (Miracle Model #1000), or bracing materials to help level and support decks and other components while concrete sets. Refer to instructions from concrete manufacturer, or allow 72 hours for concrete to fully cure.
8. Protective surfacing material should be installed on the day that equipment installation is completed.
9. Add play apparatus such as swing seats, "D" rings, and balance chains **only** when the site is ready for children, i.e. after protective surfacing material is in place.

AFTER INSTALLATION

1. Refer to the **Post-Installation Check List** (Doc. # D70040), Section 700 in *Read Me First!, Miracle's Safety, Maintenance & Installation Reference* in this *Installation Manual*.
2. Determine a suitable location for storing reference materials and spare parts. Establish an inspection, maintenance and repair routine, and adhere to it diligently.
3. Have fun watching your kids on your new Miracle playsystem!



Placement of 'Age Appropriate' Labels



Age appropriate labels should be placed near the access to the piece of playground equipment. Each label should be positioned so it is readable by a person about to use the piece of equipment.

The appropriate age range of playground equipment is based on information provided by the "CPSC Playground Safety Handbook", "ASTM F1487 Playground Safety Standard" and the professional judgement of Miracle Recreation Equipment Company.

REPLACEMENT OF AGE APPROPRIATE LABELS

If label should become illegible, torn or is removed it is necessary for the owner to replace the label. Replacement labels may be obtained by contacting your Miracle Sales Representative, by calling our Customer Service Department at **1-888-458-2752**, or by writing to:

Miracle Recreation Equipment Company
878 E. Hwy. 60
Monett, MO 65708

APPLICATION OF AGE APPROPRIATE LABELS

Prepare surface; remove any dust, oil or grime from the label location area on the post. Ensure the area is dry. When area is both clean and dry, carefully peel off label from paper backing and place on post so that it is flush and flat to the plane of the post with no wrinkles or tears. Apply firm pressure over the entire label to ensure proper adhesion.

FOR DECK SYSTEMS:

Age appropriate labels should be placed on a deck post at or near the deck access points (stairs, ramps, transfer points, ladders, etc), and approximately 5' from top of surfacing.

FOR FREESTANDING EQUIPMENT (OTHER THAN SWINGS):

Age appropriate labels should be placed on a post if available and near the equipment's access point. For equipment without posts, affix label to a painted or bare metal surface in a location clearly visible from point of access.





Placement of 'Age Appropriate' Labels

D70054 Rev. B

MIRACLE
RECREATION EQUIPMENT COMPANY

FOR SWINGS:

Choose the correct label from the ones supplied with your swing. Place the label on a swing leg, using one label for each bay of the swing set, approximately 5' from top of surfacing.

LABELS THAT WILL SHIP WITH SWING FRAMES AND BE ATTACHED TO THE LEGS:



LABELS THAT WILL SHIP WITH CANADIAN SWING FRAMES AND BE ATTACHED TO THE LEGS:



LABELS THAT WILL SHIP WITH ALL THERAPEUTIC AND MIRAGE THERAPEUTIC SWING SEATS AND BE ATTACHED TO THE LEGS:

MIRAGE



MIRAGE



THERAPEUTIC



THERAPEUTIC



Placement of 'Age Appropriate' Labels



Placement of "Warning" and "Manufacturer's I.D." Labels

D70058 Rev. C

Both a Warning Label and a Manufacturer's Identification Label are provided for all play equipment.

LOCATIONS

FOR DECK SYSTEMS:

Place Warning and I.D. Labels on a deck post at or near each deck access point (stairs, ramp entries, transfer points, ladders, etc.) Each label should be positioned so it is readable by a person entering onto the deck.

FOR NON-DECK SYSTEMS:

Place Warning and I.D. Labels on a painted/metal surface. Each label should be positioned so it is readable by a person using the play equipment.

APPLICATION OF WARNING AND I.D. LABELS

Prepare surface; remove any dust, oil or grime from the label location area on the equipment. Ensure the area is dry. When area is both clean and dry, carefully peel off label from paper backing and place on equipment so that it is flush and flat to the plane of the equipment with no wrinkles or tears.

REPLACEMENT OF WARNING AND I.D. LABELS

If label should become illegible, torn or is removed it is necessary for the owner to replace the label. Replacement labels may be obtained by calling our Customer Service Department at **1-800-523-4202**, or by writing to:

Miracle Recreation Equipment Company

878 E. Hwy 60
Monett, MO 65708 USA



WARNING LABEL



Miracle Recreation Equipment Company
www.miracle-recreation.com
1-800-523-4202 or +1-417-235-6917

MANUFACTURER'S I.D. LABEL

Please note that actual label designs may vary.



MIRACLE
RECREATION EQUIPMENT COMPANY

Torque Chart

D70055 Rev. B

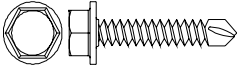
SELF DRILLING SCREW	
	
DIAMETER	RECOMMENDED TORQUE IN-LBS*
1/4	32

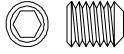
SET SCREW	
	
DIAMETER	RECOMMENDED TORQUE FT-LBS*
3/8	13

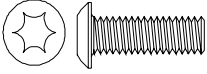
BUTTON HEAD BOLT	
	
DIAMETER	RECOMMENDED TORQUE FT-LBS*
1/4-20	5
5/16-18	10
3/8-16	17
7/16-14	30
1/2-13	45

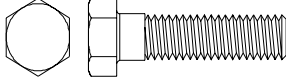
HEX HEAD BOLT	
	
DIAMETER	RECOMMENDED TORQUE FT-LBS*
1/4-20	5
5/16-18	10
3/8-16	17
7/16-14	30
1/2-13	45

* MIRACLE DOES NOT RECOMMEND THE USE OF IMPACT WRENCHES OR POWER TOOLS TO INSTALL HARDWARE.

Torque Chart



Hardware Guide



D70066 Rev. C

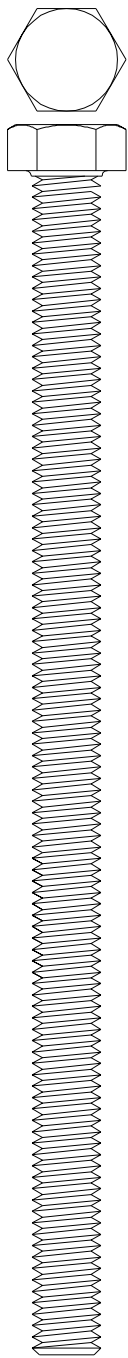
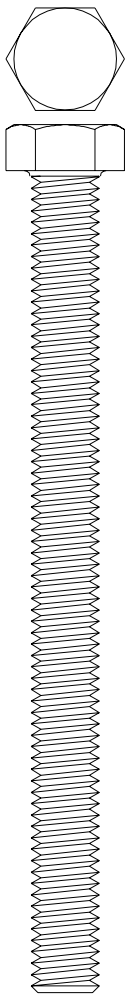
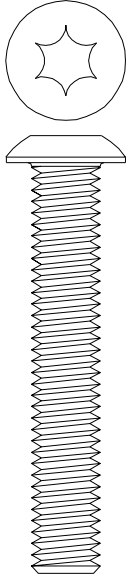
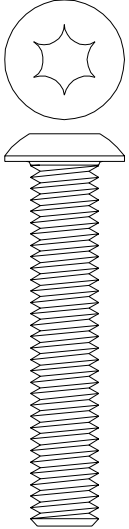
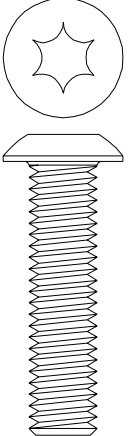
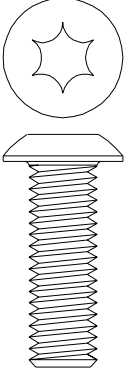
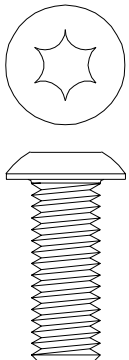
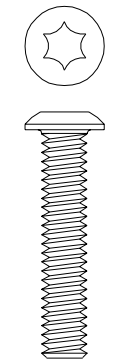
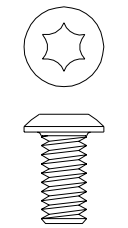
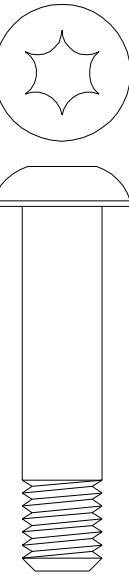
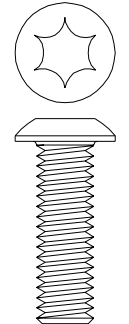
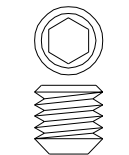
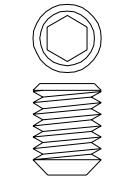
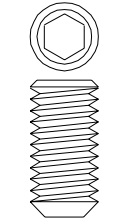
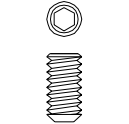

MIRACLE
RECREATION EQUIPMENT COMPANY

<p>P/N 104146 3/8-16X6-1/2 HHCS</p> 	<p>P/N 104304 3/8-16X4-1/2 HHCS</p> 	<p>P/N 104262 3/8-16X2-1/4 BHCS</p> 	<p>P/N 104097 3/8-16X2 BHCS</p> 	<p>P/N 104166 3/8-16X1-1/2 BHCS</p> 	<p>P/N 104930 3/8-16X1-1/8 BHCS</p> 
		<p>P/N 104286 3/8-16X1 BHCS</p> 	<p>P/N 104749 1/4-20X1-1/4 BHCS</p> 	<p>P/N 104470 1/4-20X1/2 BHCS</p> 	<p>P/N 104467 7/16-14X2 BHCS</p> 
	<p>P/N 104040 5/16-18X1 BHCS</p> 	<p>P/N 104285 3/8-16X3/8 SKT SET SCREW</p> 	<p>P/N 104073 3/8-16X1/2 SKT SET SCREW</p> 	<p>P/N 104049 3/8-16X3/4 SKT SET SCREW</p> 	<p>P/N 987705 10-24X3/8 SKT SET SCREW</p> 

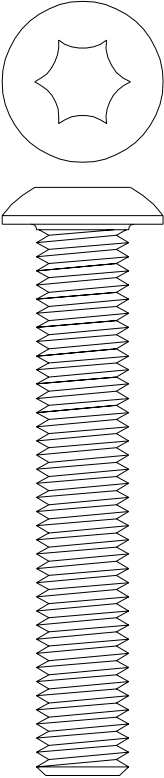
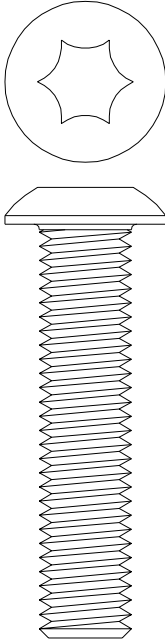
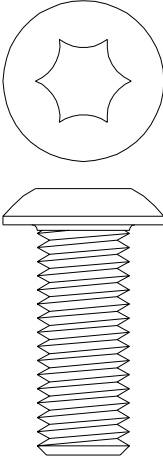
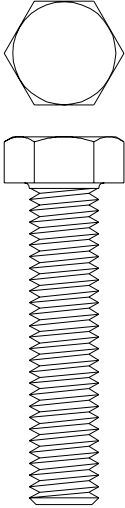
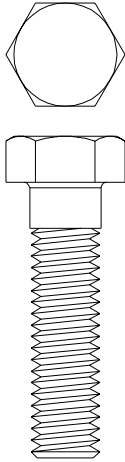
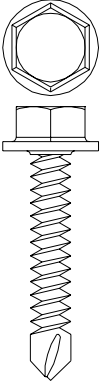
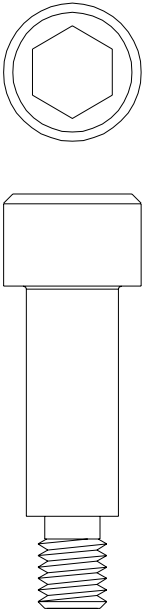
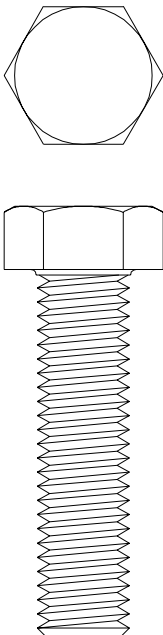
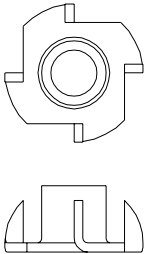
Hardware Guide

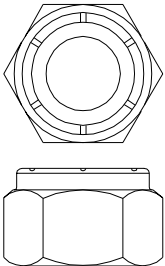
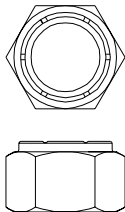
Hardware Guide

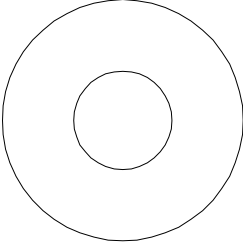
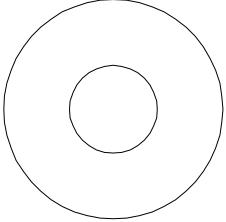
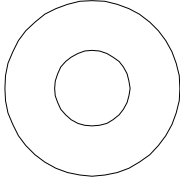
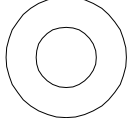
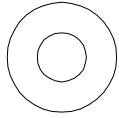
<p>P/N 104508 1/2-13X3 BHCS</p> 	<p>P/N 104155 1/2-13X2-1/4 BHCS</p> 	<p>P/N 104488 1/2-13X1-1/4 BHCS</p> 	<p>P/N 104227 3/8-16X1-3/4 HEX HD</p> 	<p>P/N 104068 3/8-16X1-1/2 HEX HD</p> 
<p>P/N 104403 1/4-14X1-1/4 HEX WSHR HD</p> 	<p>P/N 104746 1/2X1-1/2 SHLDR BOLT</p> 	<p>P/N 104153 1/2-13X2 HEX HD</p> 	<p>P/N 110156 1/4-20 NUT T 4 PRONG</p> 	<p>P/N 104357 #10X1 WAY SLT SCREW</p> 
			<p>P/N 110061 1/2-13 HEX NYLOCK</p> 	<p>P/N 110030 3/8-16 HEX NYLOCK</p> 

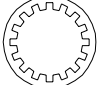
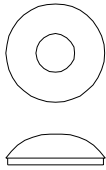
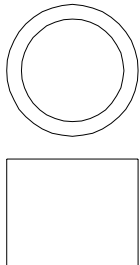
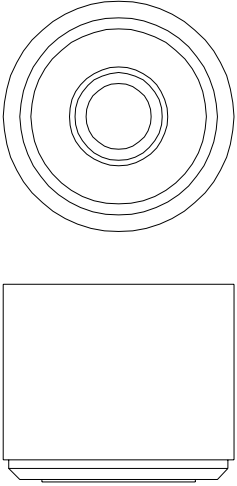
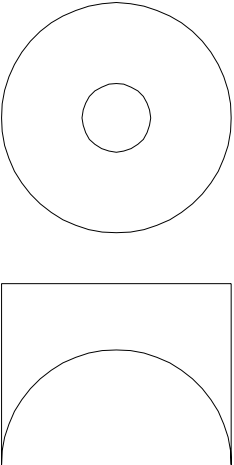
<p>P/N 117020 1/2 FLAT WASHER</p> 	<p>P/N 117007 7/16 FLAT WASHER</p> 	<p>P/N 117005 3/8 FLAT WASHER</p> 	<p>P/N 117003 5/16 FLAT WASHER</p> 	<p>P/N 117001 1/4 FLAT WASHER</p> 
<p>P/N 117103 1/4 LOK WASHER</p> 	<p>P/N 117104 5/16 LOK WASHER</p> 	<p>P/N 117105 3/8 LOK WASHER</p> 	<p>P/N 117049 #12 X 9/16 SEAL NEO. BOND WASHER</p> 	<p>P/N 983272 SPACER SUSPENSION BRIDGE</p> 
<p>P/N 713447 STUB ASSY CLAMP RAMP</p> 	<p>P/N 901897 SPACER HANDRAIL</p> 	<p>REFERENCE "INSTALLATIONS 101" FOR THE FOLLOWING PART NUMBERS:</p> <ul style="list-style-type: none"> 116021 MIRACLE ID LABEL 116022 WARNING LABEL- PLAYGROUND 116035 LABEL: 2-5 YEARS 116036 LABEL: 2-12 YEARS 116037 LABEL: 5-12 YEARS 116040 MIRACLE ID LABEL- CENTER STAGE 116041 MIRACLE ID LABEL- KIDS CHOICE 116042 MIRACLE ID LABEL- LOKVILLE 		

P/N 976468
BACK UP
FLANGE

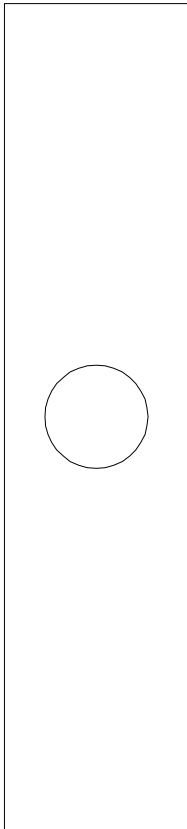

P/N 713875
KC TP STAIR
HANGER PLT PTD

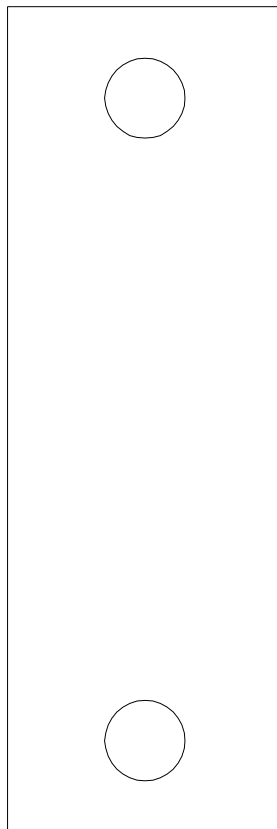

REFERENCE 714500/718500
VERSALOK FASTENING SYSTEM
INSTALLATION GUIDE FOR THE
FOLLOWING PART NUMBERS:

- 713002 BAR SOCKET,
TOP HALF 5" OD
- 713003 BAR SOCKET,
BOTTOM HALF 5" OD
- 981721 BAR SOCKET,
3.5" OD (FOR 1" TUBE)
- 982964 BAR SOCKET,
3.5" OD (FOR 1.315" TUBE)
- 713010 CLAMP RING 5" DIA.
- 983856 CLAMP RING 3.5" DIA.
- 713102 DECK SUPPORT 5" OD TUBE
- 981722 DECK SUPPORT 3.5" OD
TUBE
- 986153 CASTING, HEADER
SUPPORT
- 986903 BAR SOCKET 5" OD
TOP HALF WITH HOLE



MIRACLE
RECREATION EQUIPMENT COMPANY

*878 Highway 60
Monett, MO 65708*

www.miracle-recreation.com

1-800-523-4202

Fax 417-235-1713



